

Radius Auspex Sensor Tap 220mm

TSL.894

The TSL.894 IR Sensor Tap features a sleek wall-mounted spout with an integrated sensor, offering a minimalist design in a range of PVD finishes.

All taps and accessories from The Splash Lab are fully compatible with the Concept Washroom range. By specifying directly with us, you gain exclusive project pricing, expert guidance from our specification team, and dedicated support from start to finish.

Finish	Codes	LRV*
● Satin	TSL.894.CS	51
● Black	TSL.894.BK	58
● Brass	TSL.894.BR	51
● Copper	TSL.894.CP	58
● Bronze	TSL.894.BZ	58

*Light reflectance value

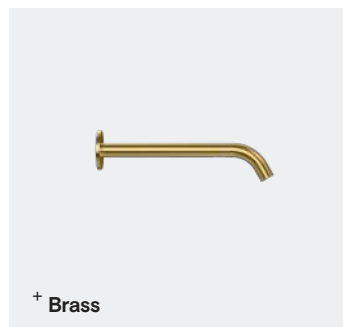

Technical Data

Body material	AISI 304 Stainless Steel
Coating type	PVD
Aerator	Cascade
Water pressure (dynamic)	0.5 to 7.5 Bar [0.05 to 0.75MPa]
Water temperature (max)	60°C
Flow rates	3.8 litres/minute - Cascade flow 1.9 litres/minute - Spray flow
Also available	1.3 litres/minute - Spray flow
Power supply	TSL .884 110-230 Vac, 50-60Hz, 1.5A TSL .886 6 V CR-P2 Lithium battery
Output (max)	6 Vdc, 1A
Power consumption	< 87% Active mode, 0.3W No load
Solenoid valve type	6V Latching
Water ingress	IP55
Cable lengths	800mm - Power supply connection 800mm - Solenoid valve connection
Sensor type	Infrared
Pre-set sensor range	220mm
Sensor range (max)	250mm
Comfort delay	2 sec
Security time-out	30 sec
Operating temperature	0 to 50°C
Response time (max)	0.3 - < 1 sec

Installation requirements

Wall cut-out hole size	ø 35mm
Depth of wall cavity (min)	90mm
Wall thickness (max)	70mm (incl. finishes)
Plumbing connection	½" BSP
Power supply cable	To be hard wired in to fused connection unit (FSU) or spur
Water supply	1.0 Bar is the recommended minimum pressure for the taps to operate effectively. 7.5 Bar is the maximum pressure for commissioning and is NOT recommended for general use. Gravity-fed systems may require a booster pump to achieve the optimal operating pressure All pipework must be thoroughly cleaned and clear of any debris before connecting the tap.
Washroom layout	Solenoid valve must be accessible for installation, commissioning and ongoing maintenance. Avoid installing the sensor tap directly opposite other sensor taps, soap dispensers, infrared devices or reflective surfaces. Careful consideration should be made when choosing the positioning of lighting and other reflective surfaces which may affect sensor performance.

Compliance & certificates

WRAS approval pending

Included

Solenoid Connector Cable
TSLP.120032

Long Range IR Sensor
TSLP.260045

Mains Power Supply 6V
TSLP.270066

Solenoid Valve
TSLP.120030

Aerator key
TSLP.260050

Aerator Cascade 3.8L/min Aerated
TSLP.260062

Aerator Cascade 1.89L/min Spray
TSLP.260063

Basket Filter For Solenoid Valve
TSLP.08530015

Optional Extras

Lithium Battery 6V
TSLP.270030

Battery Holder
TSLP.270029

Aerator Cascade 1.35L/min Spray
TSLP.260051

+ Technical drawing

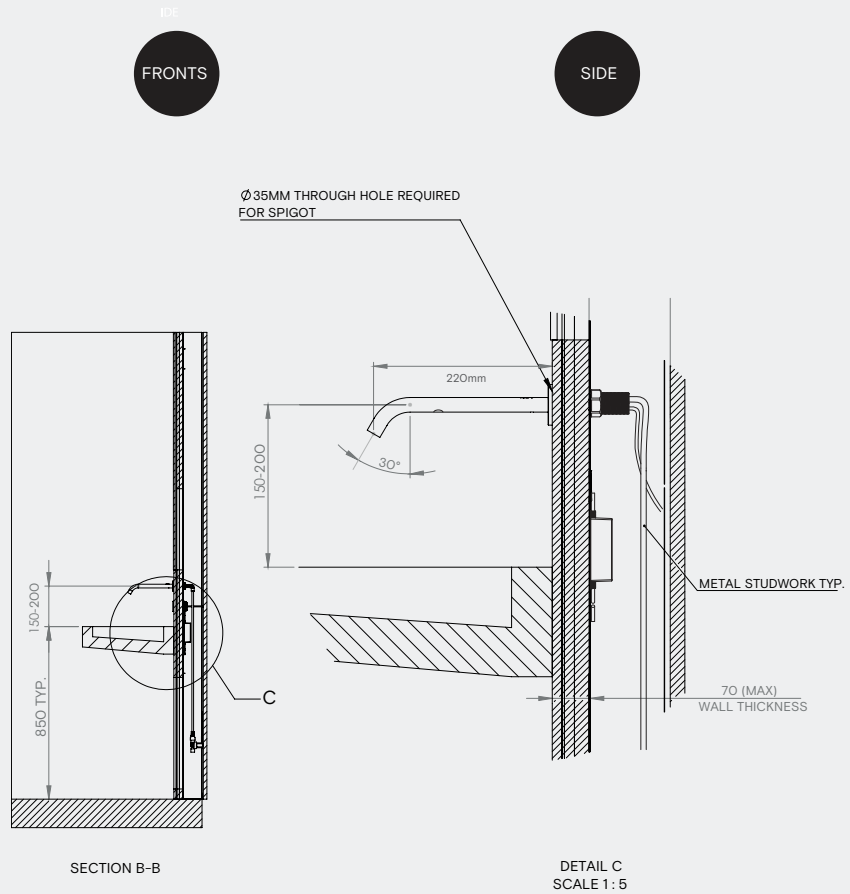

Warranty & Spare parts

For warranty terms and conditions please visit www.thesplashlab.com

If additional spare parts are required and are not listed below, please contact us at info.uk@thesplashlab.com

Compliance & certificates

WRAS approval pending

KIWA

Certificate No. 2509713



Related products



Wall Mounted Manual Soap Dispenser
TSL.470



IR Sensor Tap
TSL.882



Radius Auspex Sensor Tap 150mm
TSL.895

Additional views

A Setting out

B Installation

+ Figure A

OPTION A:
TAP TO BE SERVICEABLE FROM
BEHIND THE MIRROR (NOT SHOWN)

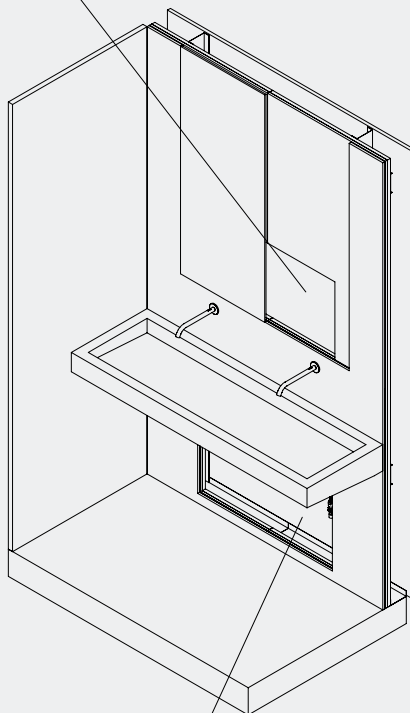

OPTION B:
TAP TO BE SERVICEABLE VIA ACCESS HATCH OR PANEL

+ Figure B

FRONT

SIDE

